





 **FANIMATION**[®]
SHOWROOM COLLECTION



220 VOLT PRODUCT



 888.567.2055

 fanimation.com

 fanimation

 fanimation

 fanimationfans

 fanimationfan

 10983 Bennett Parkway, Zionsville, Indiana 46077

FANIMATION : AIR APPARENT

Fanimation's focus is producing creative and functional fans that provide ultimate personal comfort using the latest technology for energy efficiency and seamless control. From our humble beginnings in 1984, inside Founder and CEO Tom Frampton's Pasadena, California garage, ingenuity and quality craftsmanship have been central in every product we manufacture. Our timeless and inspired fans are sought across the globe.

You will find Fanimation in some of the most luxurious locales—from tropical resorts to the heart of your home.

CHOOSING YOUR FAN

LOCATION IS EVERYTHING

- Where you will install your fan is the first step in selecting the right fan for your space.
- Dry, indoor location: Choose from any of our fans—dry, damp or wet rated.
 - Outdoor covered or high-humidity indoor location: Choose from our damp or wet rated fans.
 - Outdoor location with likely direct contact with water: Choose from our wet rated fans.

We've made it easy for you!
Look for these icons to identify location rating:

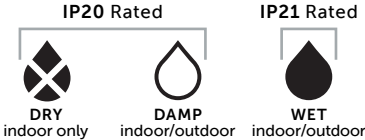

SIZE MATTERS

- The size of your room will help determine the size of your fan, identified by blade sweep. The following are general guidelines.
- Optimal performance will come from mounting your fan in the center of the room.
 - If you have a long or large room, consider the use of multiple fans
 - Scale is a personal preference. Large diameter fans can go in both small rooms and larger rooms—it's all in the look you desire.

SMALL ROOM
132cm or smaller

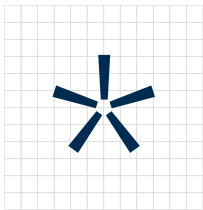

LARGE ROOM
132cm or larger

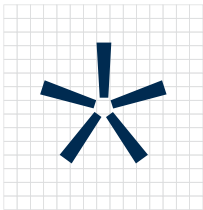

GREAT ROOM
152cm or larger

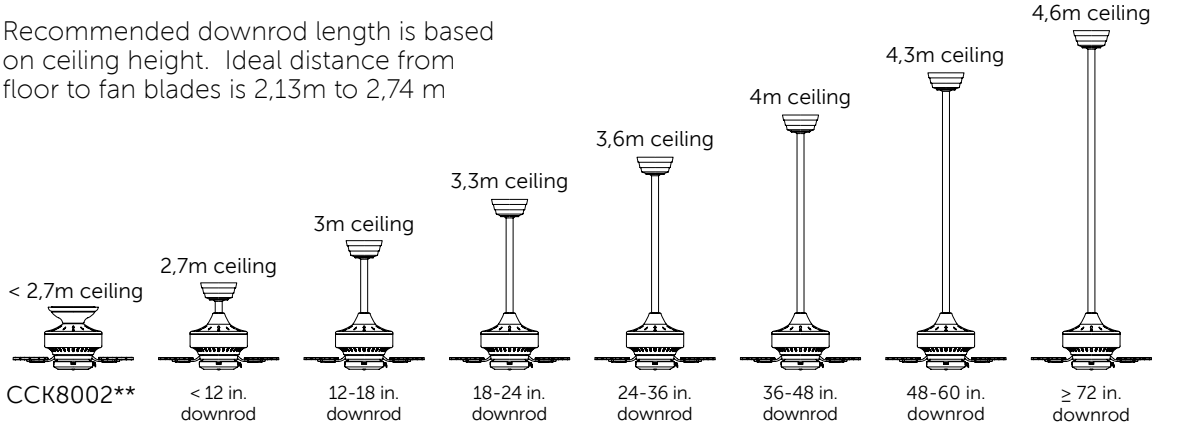
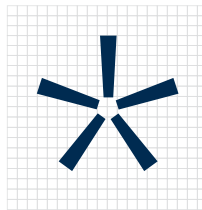

For lengths greater than 72 in., join two downrods with DR1-CP** coupler

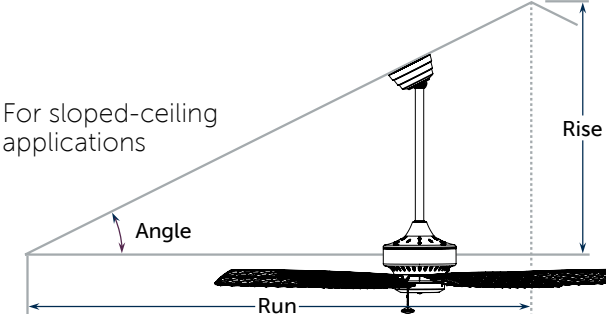





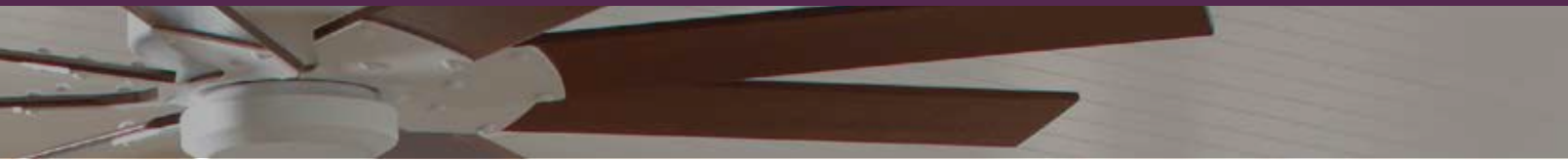



Pitch (Rise/Run)	Angle	Minimum Downrod
1/12	4.8°	Standard
2/12	9.5°	6 in.
3/12	14.0°	12 in.
4/12	18.4°	12 in.
5/12	22.6°	18 in.
6/12	26.5°	18 in.
7/12	30.3°	24 in.
8/12	33.7°	24 in.
> 8/12	> 33.7°	> 36 in.

Ideal distance from floor to fan blades is 2.13-2.74m.



IDENTIFYING FEATURES IMPORTANT TO YOU

We offer a diverse line of fans with equally diverse features. As you choose your fan, identify the features that matter to you—use Features Legend below to understand the Features icons.

fan control type				light kit included + lamping info	number of fan speeds + location of reversing switch	fan, blades and light sold separately	features energy- efficient DC motor
 CONTROL wall	 CONTROL remote	 CONTROL pull chain	 CONTROL rotary	 WATTAGE bulb style	 SPEED reverse location		

UNDERSTANDING AIRFLOW

We provide airflow information—at high speed—for each fan. Airflow is measured in CFM (cubic feet per minute), energy used is measured in watts and the energy efficiency of the fan is measured in CFM per watt.

ENERGY INFORMATION AT HIGH SPEED:

Airflow	Electricity Use	Airflow Efficiency
6942 Cubic Feet Per Minute	65 Watts (excluding lights)	107 Cubic Feet Per Minute Per Watt
The greater the number, the greater the air moved	Energy consumed	The greater the number, the more efficient the fan is

FANIMATION MOTORS—AC AND DC

All Fanimation motors are built using high quality materials and components, insuring years of reliable and dependable operation for every Fanimation fan.

- Our fans are equipped with either an AC motor or DC motor.
- AC motors use supplied power directly and regulate speeds by controlling frequency.
- DC motors convert supplied power and regulate speeds by controlling electrical current.
- Our AC motors come in 1-, 3- and 4-speed variants.
- Our DC motors come with 6 speeds. DC motors are more efficient, generate more torque and are virtually silent.

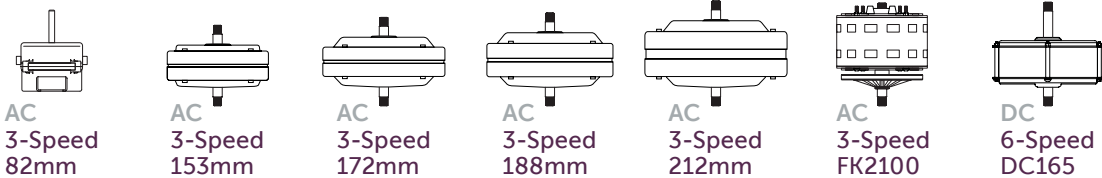

SEASONAL CEILING FAN USE

Ceiling fans save money year-round when turning in the proper direction.

WARM WEATHER
Airflow with counter-clockwise rotation, as you look up, provides a cooling breeze

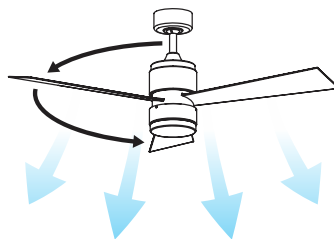

COOL WEATHER
Airflow with clockwise rotation, as you look up, forces warm air downward

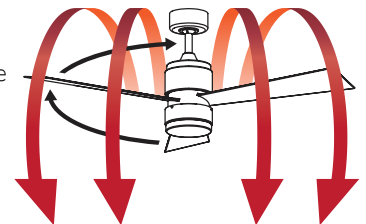

Need more assistance? Call 1-888-567-2055

INDOOR

AIRE DÉCOR
16



BENITO
14



BOURBON STREET
17



ENIGMA
28



LEVON AC
12



PALMETTO
18



ZONIX
10



INDOOR/OUTDOOR

AMERICANA
50



ASCENSION
30



BELLERIA
46

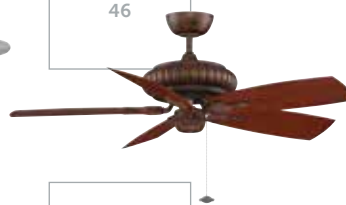

BREWMASTER
54



EDGEWOOD DELUXE WET
42



EDGEWOOD WET
40



EXTRAORDINAIRE
26



HUGH 44
22



HUGH 52
24



ISLANDER AC
48



ODYN
36



PUNKAH
52



SPITFIRE
38



WINDPOINTE CUSTOM
44



XENO WET
32



ZONIX WET
34

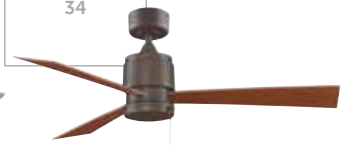

PORTABLES

ARDEN
58



MINI BREEZE
60



ACCESSORIES

BLADES
65



CONTROLS
63



LIGHTING
61



DOWNRODS &
ACCESSORIES
62



TABLE OF CONTENTS

Aire Décor®	16
Americana®	50
Arden™	58
Ascension™	30
Belleria®	46
Benito™	14
Bourbon Street®	17
Brewmaster®	54
Edgewood® Deluxe Wet	42
Edgewood® Wet	40
Enigma®	28
Extraordinaire®	26
Hugh™ 44	22
Hugh™ 52	24
Islander®	48
Levon™	12
Mini Breeze™	60
Odyn™	36
Palmetto®	18
Punkah®	52
Spitfire™	38
Windpointe® Custom	44
Xeno™ Wet	32
Zonix™	10
Zonix™ Wet	34
Choosing Your Fan.....	3
Lighting Kits	61
Fitters, Shades & Decorative Glass.....	61
Downrods & Accessories	62
Wall Controls.....	63
Remote Controls	64
Blades	65
Antique Fan Museum	67
Index	69





INDOOR

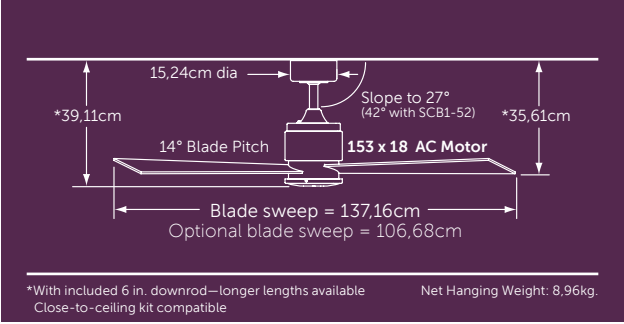

FAN: FP4620OB-220 (1)
oil-rubbed bronze assembly with reversible cherry/walnut wood blades
● cherry side showing



FAN: FP4620SN-220 (1)
satin nickel assembly with reversible cherry/walnut wood blades
● cherry side showing



SOLD SEPARATELY:



See page 63-64 for optional controls

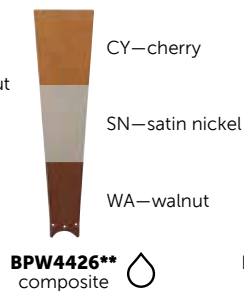

ZONIX™

 **FAN: FP4620SN-220 (1)**
satin nickel assembly with
reversible cherry/walnut
wood blades

- walnut side showing

oil-rubbed bronze	satin nickel
cherry walnut	cherry walnut
FP4620OB-220	FP4620SN-220

INCLUDED:



blade set



CW40-220

ENERGY INFORMATION
AT HIGH SPEED:

Airflow
3952
Cubic Feet
Per Minute

Electricity Use
38
Watts
(excluding lights)

Airflow Efficiency
104
Cubic Feet Per
Minute Per Watt

4-SPEED AC
reverse switch
on fan

CONTROL
wall

DRY (IP20)
indoor only

LIMITED LIFETIME MOTOR WARRANTY

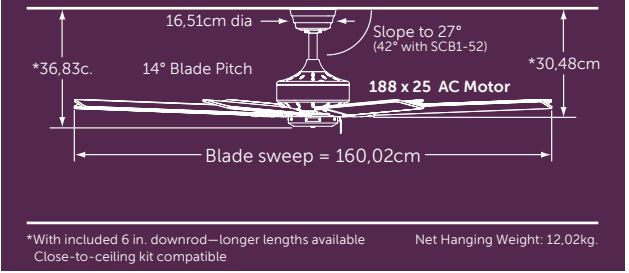

FAN: FP7910OB-220 (1)
oil-rubbed bronze assembly
with walnut blades

SOLD SEPARATELY:



See page 63-64 for
optional controls

LEVON™

FAN: FP7910OB-220 (1)
oil-rubbed bronze assembly
with walnut blades

oil-rubbed
bronze
walnut
FP7910OB-220

3-SPEED AC
reverse switch
on fan

CONTROL
pull chain

DRY (IP20)
indoor only

INCLUDED:

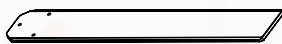

blade set

ENERGY INFORMATION
AT HIGH SPEED:

Airflow
5151
Cubic Feet
Per Minute

Electricity Use
58
Watts
(excluding lights)

Airflow Efficiency
89
Cubic Feet Per
Minute Per Watt

LIMITED LIFETIME MOTOR WARRANTY

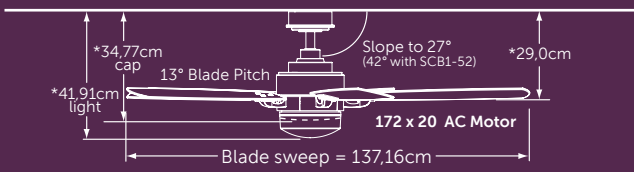

*With included 4.5 in. downrod—longer lengths available
Close-to-ceiling kit compatible

Net Hanging Weight: 8.89kg.



SOLD SEPARATELY:



See page 63-64 for optional controls

BENITO™

FAN: FP8003BN-220 (1)
 brushed nickel assembly with
 opal frosted glass and reversible
 cherry/walnut wood blades
 • walnut side showing

brushed nickel	matte white
cherry	walnut
FP8003BN-220	FP8003MW-220



(2) 9W
CFL base



3-SPEED AC
reverse switch
on fan



CONTROL
remote



DRY (IP20)
indoor only

INCLUDED:



blade set



light kit
light cover



TRL4WH-220

ENERGY INFORMATION AT HIGH SPEED:

Airflow
5535
Cubic Feet
Per Minute

Electricity Use
60
Watts
(excluding lights)

Airflow Efficiency
92
Cubic Feet Per
Minute Per Watt

LIMITED LIFETIME MOTOR WARRANTY

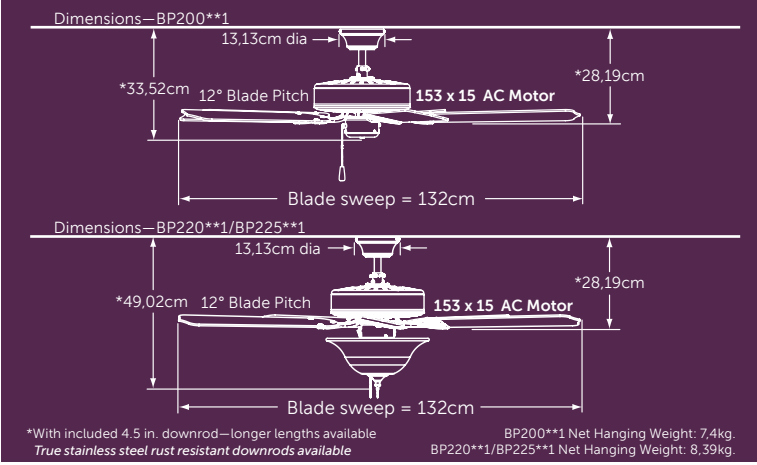

FAN: BP200MW1-220 (1)
matte white assembly in
downrod configuration with
matte white wood blades



FAN: BP200OB1-220 (1)
oil-rubbed bronzed assembly in
downrod configuration with reversible
cherry/walnut wood blades
● walnut side showing



FAN: BP200SN1-220 (1)
satin nickel assembly in flush-mount
configuration with reversible cherry/
walnut wood blades
● cherry side showing



FAN: BP220MW1-220 (1)
matte white assembly in downrod
configuration with white frosted glass
bowl and matte white wood blades



SOLD SEPARATELY:



control options: p.63-64
light options: p.61

AIRE DECOR®

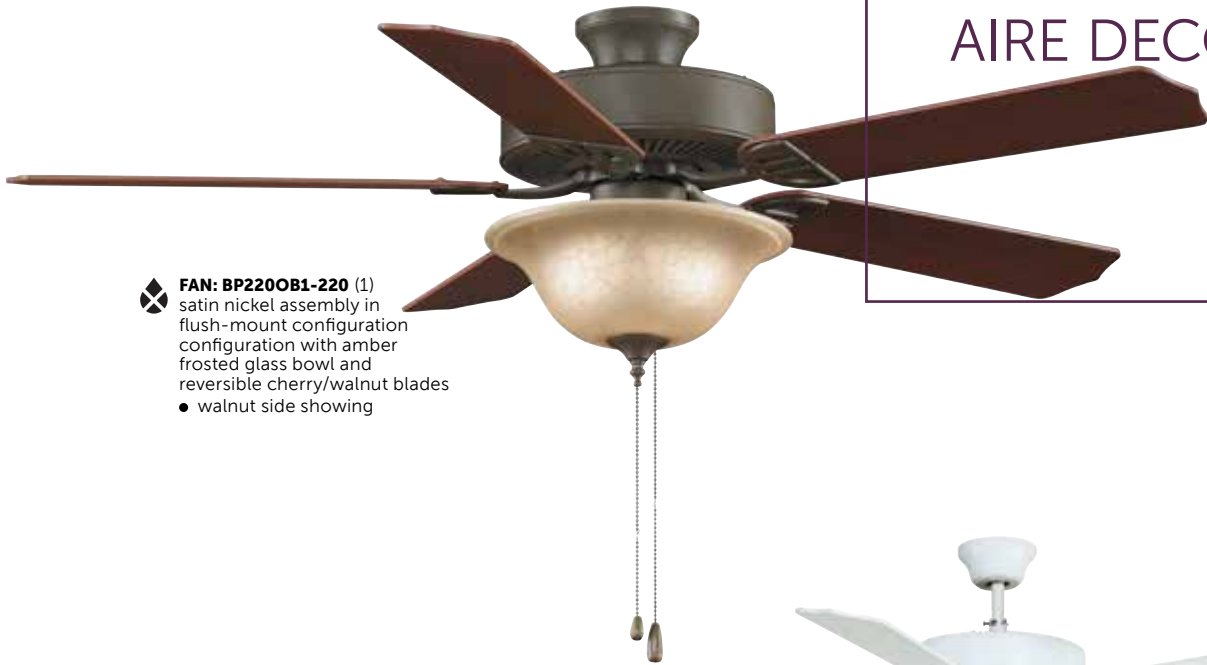

FAN: BP220OB1-220 (1)
satin nickel assembly in flush-mount configuration with amber frosted glass bowl and reversible cherry/walnut blades
● walnut side showing



FAN: BP220MW1-220 (1)
matte white assembly in downrod configuration with white frosted glass bowl and matte white wood blades



FAN: BP225OB1-220 (1)
oil-rubbed bronze assembly in downrod configuration with white frosted glass bowl (amber glass version available: BP220OB1-220) and cherry/walnut reversible wood blades
● walnut side showing

matte white	oil-rubbed bronze	satin nickel
matte white	cherry walnut	cherry walnut
BP200MW1-220 BP220MW1-220	BP200OB1-220 BP220OB1-220 BP225OB1-220	BP200SN1-220 BP220SN1-220

- SEE INCLUDED incandescent candelabra
- 3-SPEED AC reverse switch on fan
- CONTROL pull chain
- DRY (IP20) indoor only

INCLUDED:



blade set



light kit—(3) 60W (bulbs not included)

BP220**1-220 & BP225OB1-220

ENERGY INFORMATION AT HIGH SPEED:

Airflow	Electricity Use	Airflow Efficiency
4510	49	93
Cubic Feet Per Minute	Watts (excluding lights)	Cubic Feet Per Minute Per Watt

LIMITED LIFETIME MOTOR WARRANTY

Due to their complex systems, multiple components and special installation requirements, we recommend contacting our Customer Service department for assistance with ordering—888.567.2055

For dimensions and configurations, please see our comprehensive Specification Book or model-specific specification sheet, available at www.fanimation.com

BOURBON STREET®

- ✦ **MOTOR: FP580BL-220** (1)
black (required but not shown)
- HEAD: FP510BL** (3)
black short assembly
- BLADES: FP1018** (3)
132cm sweep reversible oak/
walnut wood
- oak side showing

PALMETTO®

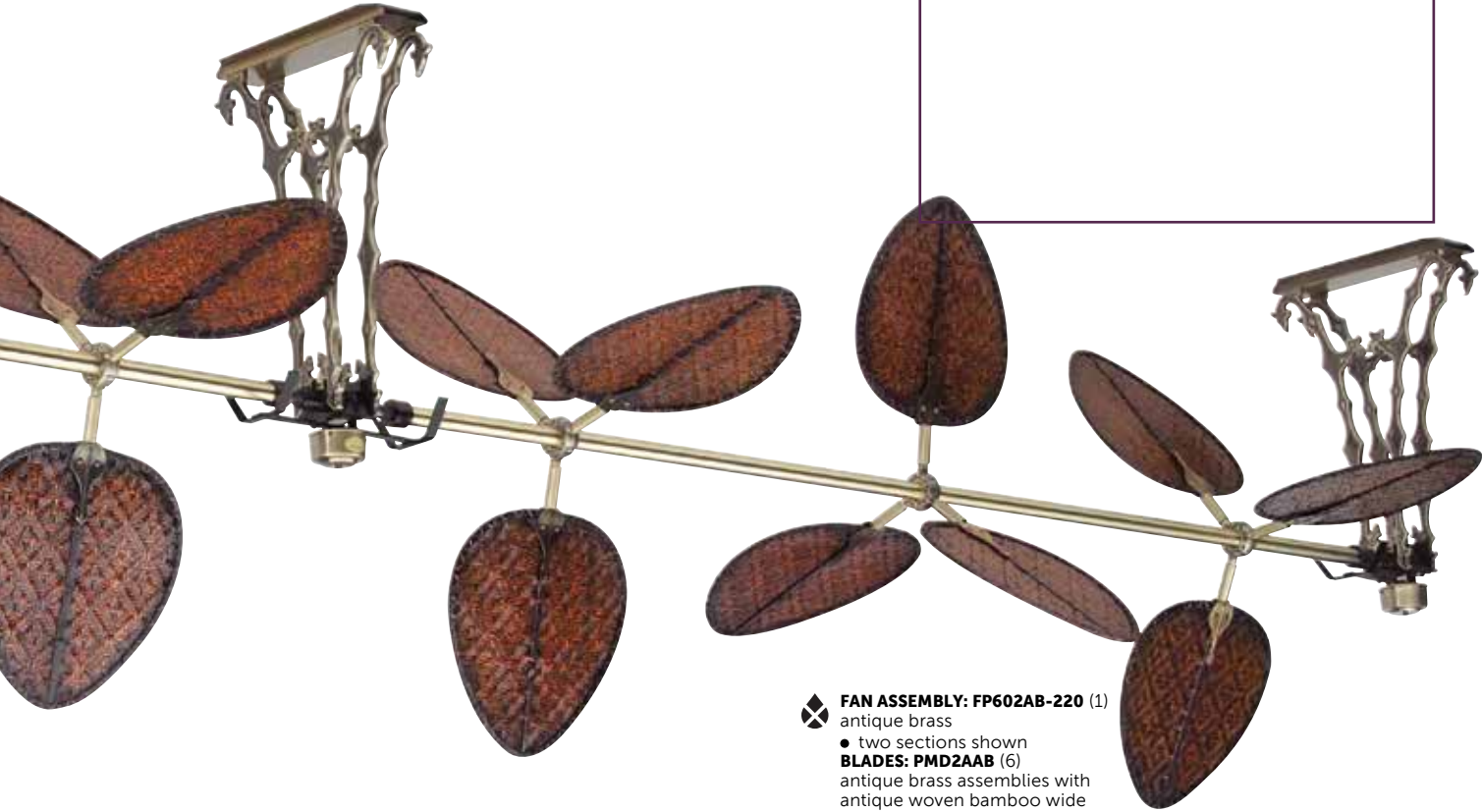

FAN ASSEMBLY: FP602AB-220 (1)
antique brass
● two sections shown
BLADES: PMD2AAB (6)
antique brass assemblies with
antique woven bamboo wide
oval blades







INDOOR/OUTDOOR

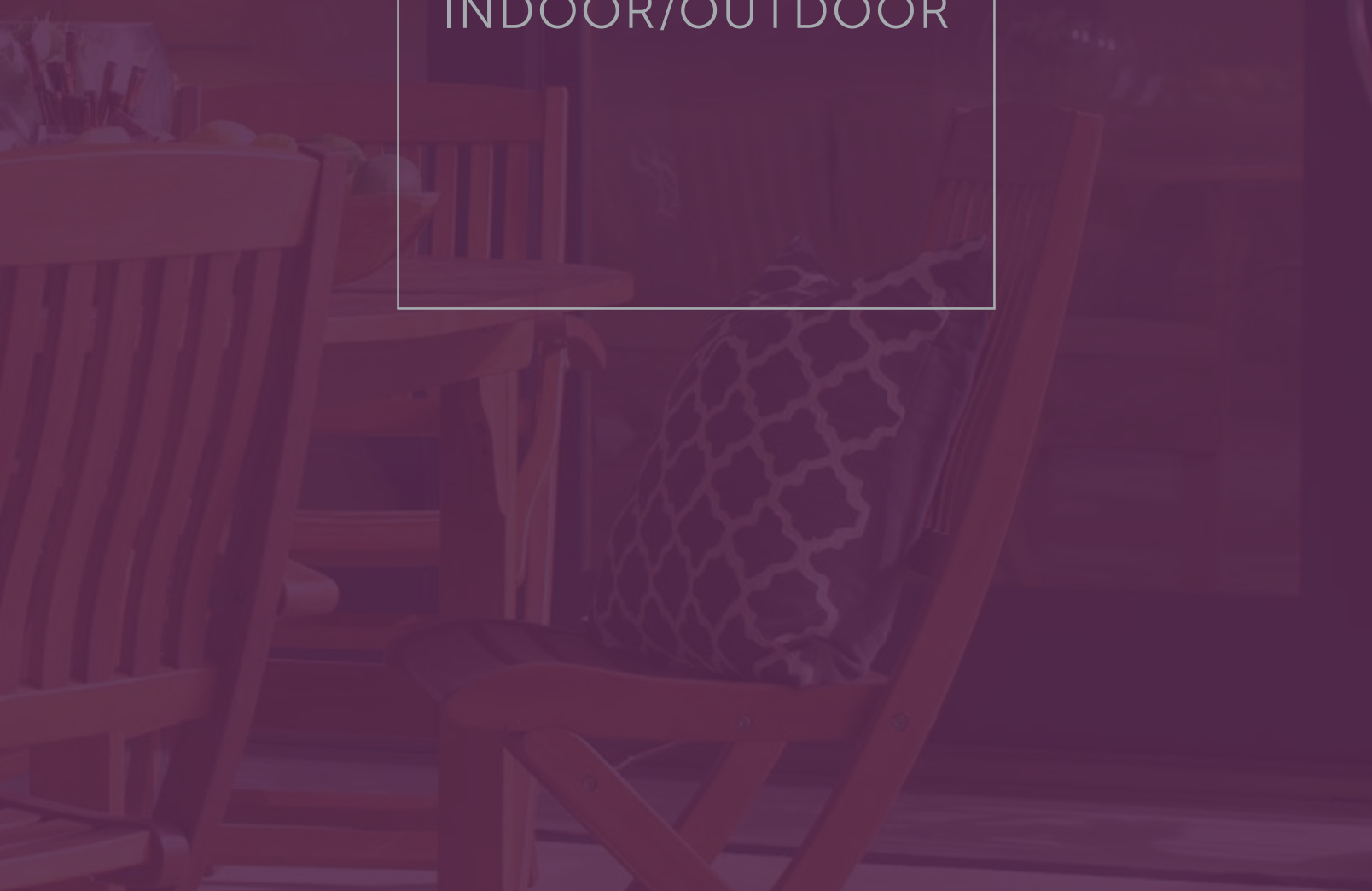

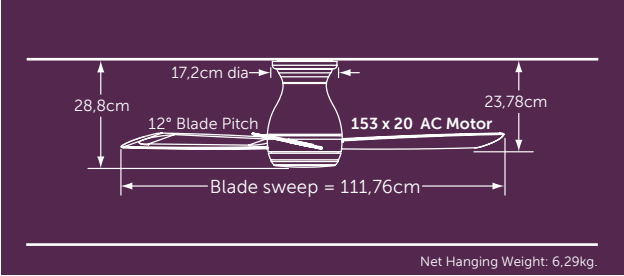

FAN: FPS8332BNW-220 (1)
brushed nickel assembly with brushed nickel blades and matching brushed nickel light cover (included)



FAN: FPS8332DZW-220 (1)
dark bronze assembly with dark bronze blades and opal frosted glass



FAN: FPS8332GRW-220 (1)
matte greige assembly with matte greige blades and matching matte greige light cover (included)



FAN: FPS8332MWW-220 (1)
matte white assembly with matte white blades and opal frosted glass



SOLD SEPARATELY:



See page 63-64 for optional controls

HUGH™ 44

FAN: FPS8332MWW-220 (1)
matte white assembly with opal frosted glass and matte white blades

brushed nickel	dark bronze	matte greige	matte white
brushed nickel	dark bronze	matte greige	matte white
FPS8332BNW-220	FPS8332DZW-220	FPS8332GRW-220	FPS8332MWW-220

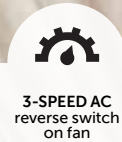

INCLUDED:

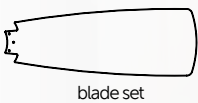

ENERGY INFORMATION AT HIGH SPEED:

Airflow
4147
Cubic Feet Per Minute

Electricity Use
52
Watts (excluding lights)

Airflow Efficiency
81
Cubic Feet Per Minute Per Watt

LIMITED LIFETIME MOTOR WARRANTY

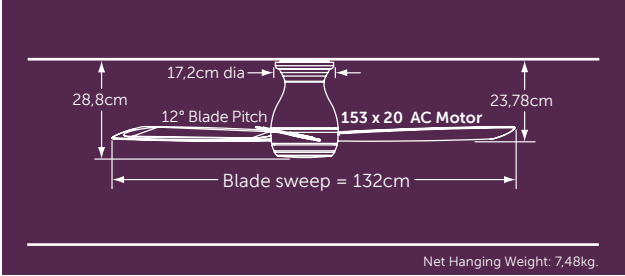

FAN: FPS8355BNW-220 (1)
brushed nickel assembly with brushed
nickel blades and matching brushed
nickel light cover (included)



FAN: FPS8355DZW-220 (1)
dark bronze assembly with
dark bronze blades and opal
frosted glass



FAN: FPS8355GRW-220 (1)
matte greige assembly with matte
greige blades and matching matte
greige light cover (included)



FAN: FPS8355MWW-220 (1)
matte white assembly with
matte white blades and opal
frosted glass



SOLD SEPARATELY:



See page 63-64 for
optional controls

HUGH™ 52

FAN: FPS8355DZW-220 (1)
dark bronze assembly with
dark bronze blades and
matching dark bronze light
cover (included)

brushed nickel	dark bronze	matte greige	matte white
brushed nickel	dark bronze	matte greige	matte white
FPS8355BNW-220	FPS8355DZW-220	FPS8355GRW-220	FPS8355MWW-220

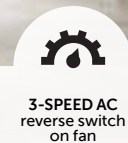

INCLUDED:



ENERGY INFORMATION AT HIGH SPEED:

Airflow
5300
Cubic Feet Per Minute

Electricity Use
52
Watts (excluding lights)

Airflow Efficiency
103
Cubic Feet Per Minute Per Watt

LIMITED LIFETIME MOTOR WARRANTY

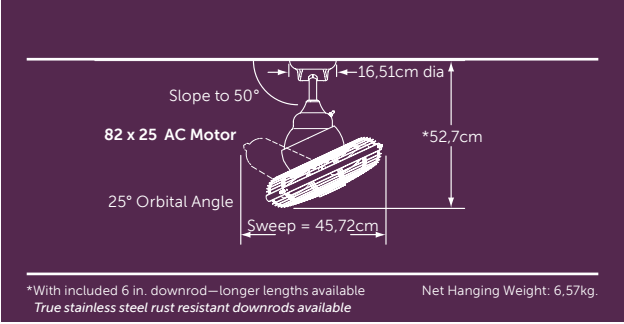



FAN: OF110OB-220 (1)
 oil-rubbed bronze assembly with black cage



FAN: OF110PW-220 (1)
 pewter assembly with black cage

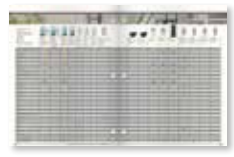

SOLD SEPARATELY:



See page 63-64 for optional controls

EXTRAORDINAIRE™



 **FAN: OF110OB-220 (1)**
oil-rubbed bronze
assembly with black cage

oil-rubbed bronze	pewter
black	black
OF110OB-220	OF110PW-220

-  **3-SPEED AC**
no reverse
-  **CONTROL**
wall
-  **DRY/DAMP (IP20)**
model specific

INCLUDED:





CW110WH-220

ENERGY INFORMATION
AT HIGH SPEED:

Airflow	Electricity Use	Airflow Efficiency
1587	71	22
Cubic Feet Per Minute	Watts (excluding lights)	Cubic Feet Per Minute Per Watt

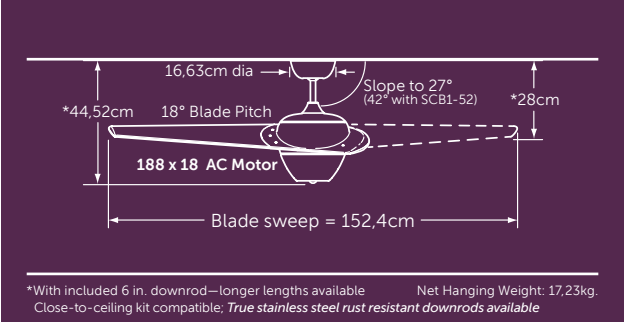
LIMITED LIFETIME MOTOR WARRANTY



 **FAN: FP2120MG-220 (1)**
metro gray assembly



 **FAN: FP2120MG-220 (1)**
metro gray assembly



SOLD SEPARATELY:



See page 63-64 for optional controls

ENIGMA™



FAN: FP2120MG-220 (1)
metro gray assembly

metro gray
metro gray
metro gray
FP2120MG-220



3-SPEED AC
no reverse



CONTROL
remote



DAMP (IP20)
indoor/outdoor

INCLUDED:



blade



TR4WH-220

ENERGY INFORMATION AT HIGH SPEED:

Airflow
5796
Cubic Feet Per Minute

Electricity Use
51
Watts (excluding lights)

Airflow Efficiency
114
Cubic Feet Per Minute Per Watt

LIMITED LIFETIME MOTOR WARRANTY

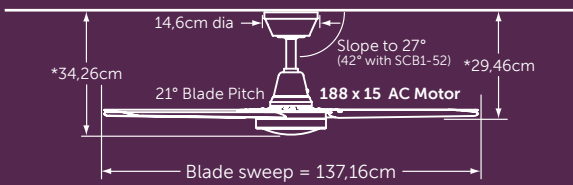

*With included 6 in. downrod—longer lengths available
 True stainless steel rust resistant downrods available

NOTE: DISTANCE FROM FLOOR TO BLADES MUST BE AT LEAST 10 FEET FOR THE ASCENSION™

FAN: FP6717BN-220 (1)
 brushed nickel assembly with
 brushed nickel blades



FAN: FP6717MW-220 (1)
 matte white assembly with matte
 white blades



SOLD SEPARATELY:



See page 63-64 for
 optional controls

ASCENSION™

 **FAN: FP6717BN-220 (1)**
brushed nickel assembly with
brushed nickel blades

brushed nickel	matte white
brushed nickel	matte white
FP6717BN-220	FP6717MW-220

INCLUDED:

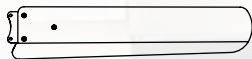

blade set



CW6717WH-220

ENERGY INFORMATION
AT HIGH SPEED:

Airflow	Electricity Use	Airflow Efficiency
6629	53	126
Cubic Feet Per Minute	Watts (excluding lights)	Cubic Feet Per Minute Per Watt



3-SPEED AC
reverse switch
on fan

CONTROL
wall

DAMP (IP20)
indoor/outdoor

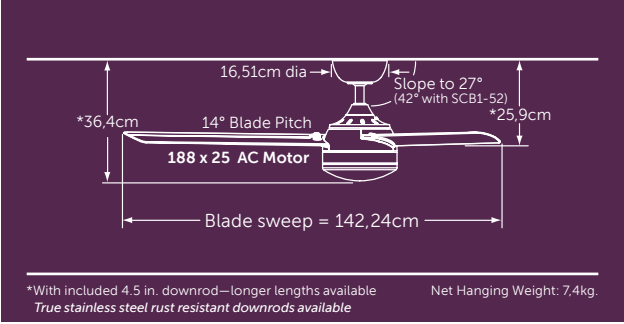

LIMITED LIFETIME MOTOR WARRANTY



FAN: FP6729BNW-220 (1)
brushed nickel assembly with
opal frosted glass and brushed
nickel blades



FAN: FP6729DZW-220 (1)
dark bronze assembly with
opal frosted glass and dark
bronze blades



FAN: FP6729MWW-220 (1)
matte white assembly with
opal frosted glass and matte
white blades



SOLD SEPARATELY:



See page 63-64 for
optional controls

XENO™ WET

FAN: FP6729BNW-220 (1)
brushed nickel assembly
with opal frosted glass and
brushed nickel blades

brushed nickel	dark bronze	matte white
brushed nickel	dark bronze	matte white
FP6729BNW-220	FP6729DZW-220	FP6729MWW-220



**18W
LED**



**3-SPEED AC
reverse switch
on fan**



**CONTROL
wall**



**WET (IP21)
indoor/outdoor**

INCLUDED:

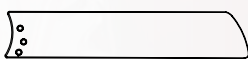

blade set



light kit



CW6729-220

ENERGY INFORMATION AT HIGH SPEED:

Airflow
6545
Cubic Feet
Per Minute

Electricity Use
58
Watts
(excluding lights)

Airflow Efficiency
113
Cubic Feet Per
Minute Per Watt

LIMITED LIFETIME MOTOR WARRANTY

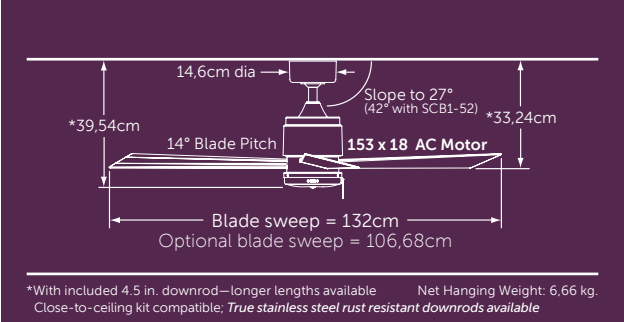

FAN: FP4640OB-220 (1)
oil-rubbed bronze assembly with
cherry all weather composite blades

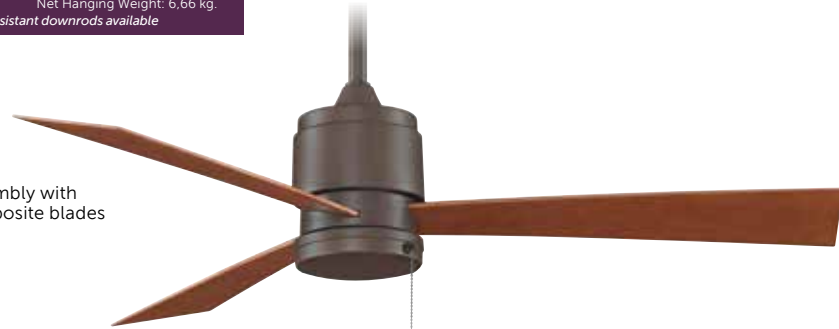

FAN: FP4640SN-220 (1)
satin nickel assembly with satin
nickel all weather composite blades



FAN: FP4640WH-220 (1)
white assembly with white all
weather composite blades



FAN: FP4640OB-220 (1)
oil-rubbed bronze assembly
with cherry all weather
composite blades
LIGHT KIT: LK4640OB-220 (1)
oil-rubbed bronze finish 18W
LED light kit



SOLD SEPARATELY:



See page 63-64 for
additional control options

CY—cherry
WA—walnut
SN—satin nickel
WH—white

BPW4426** composite

LK4640-220**
18W LED

use with
CW4640-220WH



CW4640-220WH
wall control

ZONIX™ WET

FAN: FP4640OB-220 (1)
oil rubbed bronze
assembly with cherry all
weather composite blades

oil-rubbed bronze	satin nickel	white
cherry	satin nickel	white
FP4640OB-220	FP4640SN-220	FP4640WH-220

INCLUDED:



blade set

ENERGY INFORMATION
AT HIGH SPEED:

Airflow
4946
Cubic Feet
Per Minute

Electricity Use
43
Watts
(excluding lights)

Airflow Efficiency
115
Cubic Feet Per
Minute Per Watt

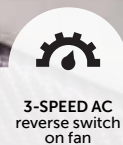

LIMITED LIFETIME MOTOR WARRANTY

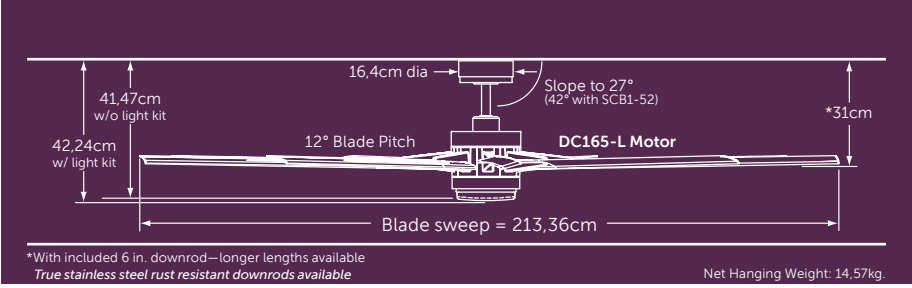

FAN: FPD8148BN-220 (1)
 brushed nickel assembly with
 brushed nickel blades and matching
 brushed nickel light cover (included)



FAN: FPD8148MW-220 (1)
 matte white assembly with
 matte white blades and opal
 frosted glass



SOLD SEPARATELY:



See page 63-64 for
 optional controls

ODYN™

FAN: FPD8148BN-220 (1)
brushed nickel assembly
with brushed nickel blades
and opal frosted glass

brushed nickel	matte white
brushed nickel	matte white
FPD8148BN-220	FPD8148MW-220

- ENERGY SAVINGS
- 18W LED
- 6-SPEED DC reverse switch on fan
- CONTROL remote
- DAMP (IP20) indoor/outdoor

INCLUDED:

- blade set
- light kit
- light cover
- TR39ND-220

ENERGY INFORMATION AT HIGH SPEED:

Airflow	Electricity Use	Airflow Efficiency
10,104	32	314
Cubic Feet Per Minute	Watts (excluding lights)	Cubic Feet Per Minute Per Watt



LIMITED LIFETIME MOTOR WARRANTY

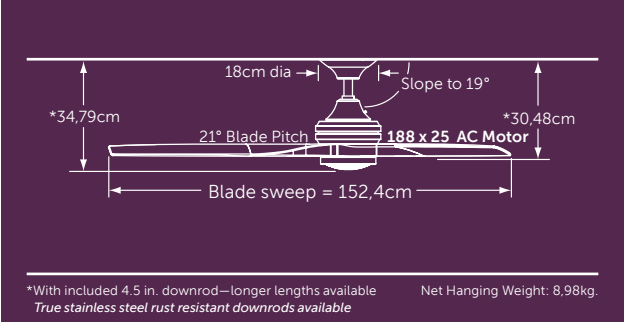

MOTOR: MA6721BN-220 (1)
 brushed nickel assembly
BLADES: B6720BN (1)
 brushed nickel finish buttonwood



MOTOR: MA6721DZ-220 (1)
 dark bronze assembly
BLADES: B6720N (1)
 natural finish buttonwood



MOTOR: MA6721GR-220 (1)
 matte greige assembly
BLADES: B6720WE (1)
 weathered wood finish buttonwood
LIGHT KIT: LK6721GR-220 (1)
 matte greige with frosted fresnel glass



SOLD SEPARATELY:



See page 63-64 for optional controls



B6720** 
button wood

- BN—brushed nickel
- DF—driftwood
- DWA—dark walnut
- N—natural
- WE—weathered wood
- WK—whiskey wood







LK6721-220** 
18W LED

SPITFIRE™



- 
MOTOR: MA6721DZ-220 (1)
 dark bronze assembly
- BLADES: B6720N (1)**
 natural finish buttonwood
- LIGHT KIT: LK6721DZ-220 (1)**
 dark bronze with frosted fresnel glass

- brushed nickel
MA6721BN-220
- dark bronze
MA6721DZ-220
- matte greige
MA6721GR-220

- 
MIX & MATCH
 components
 sold separately
- 
3-SPEED AC
 reverse switch
 on fan
- 
CONTROL
 wall
- 
DAMP (IP20)
 indoor/outdoor

INCLUDED:



CW6721WH-220

ENERGY INFORMATION AT HIGH SPEED:

Airflow	Electricity Use	Airflow Efficiency
6774	53	127
Cubic Feet Per Minute	Watts (excluding lights)	Cubic Feet Per Minute Per Watt



LIMITED LIFETIME MOTOR WARRANTY

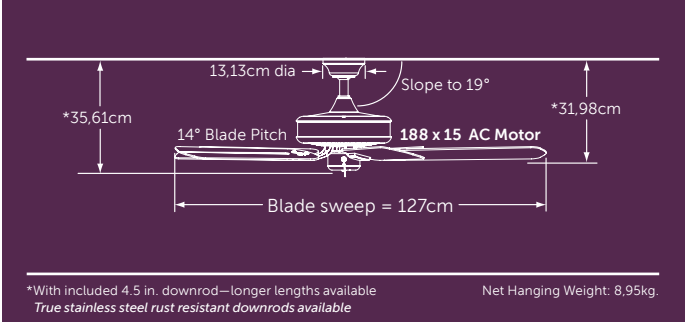

FAN: TF910AZ-220 (1)
 aged bronze assembly with
 dark cherry all-weather
 composite blades



FAN: TF910WH-220 (1)
 white assembly with
 white all-weather
 composite blades

SOLD SEPARATELY:



control options: p.63-64
 light options: p.61

EDGEWOOD® WET

FAN: TF910WH-220 (1)
white assembly with all-weather composite white blades

aged bronze	white
dark cherry	white
TF910AZ-220	TF910WH-220

INCLUDED:



blade set

ENERGY INFORMATION
AT HIGH SPEED:

Airflow
5272
Cubic Feet
Per Minute

Electricity Use
53
Watts
(excluding lights)

Airflow Efficiency
99
Cubic Feet Per
Minute Per Watt

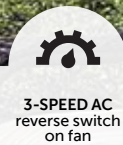

3-SPEED AC
reverse switch
on fan



CONTROL
pull chain



WET (IP21)
indoor/outdoor



LIMITED LIFETIME MOTOR WARRANTY

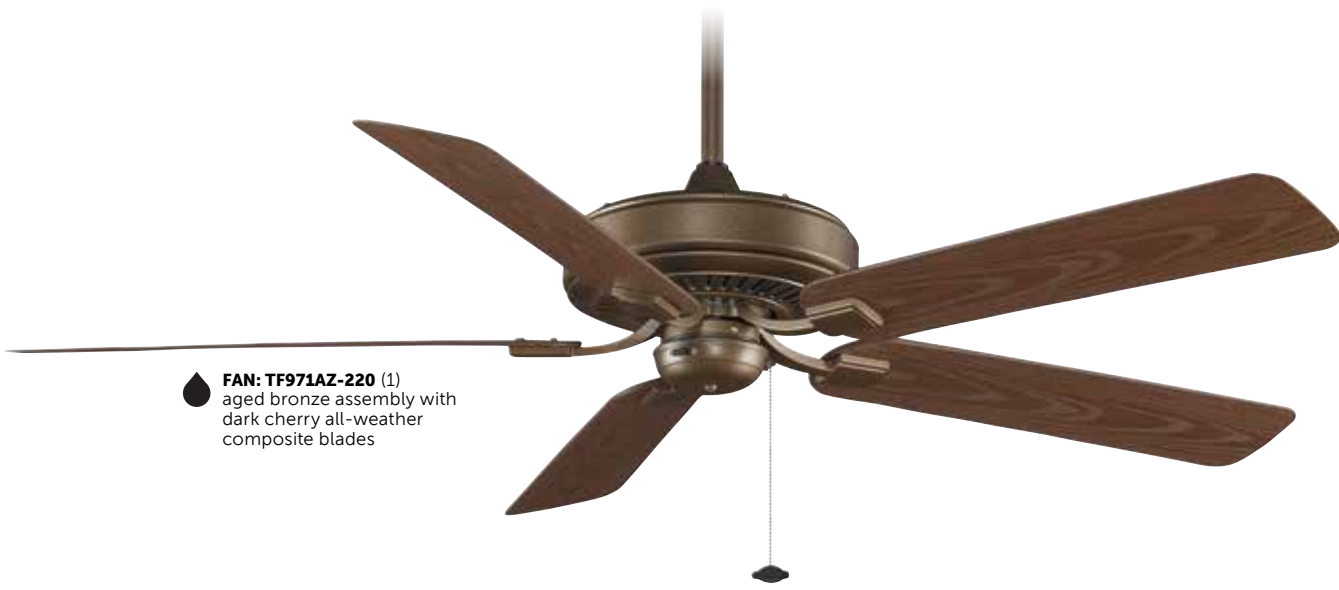
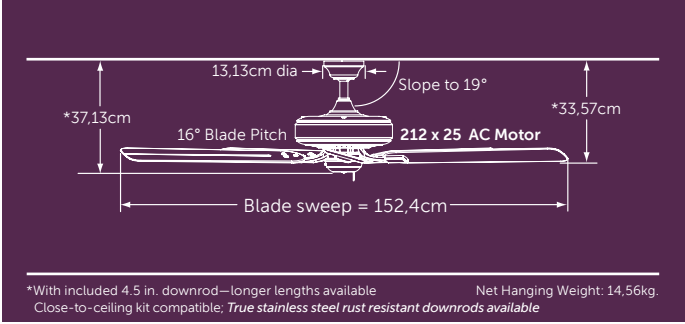

FAN: TF971AZ-220 (1)
aged bronze assembly with
dark cherry all-weather
composite blades



SOLD SEPARATELY:



control options: p.63-64
light options: p.61



EDGEWOOD® DELUXE WET

FAN: TF971AZ-220 (1)
aged bronze assembly with
all-weather composite
dark cherry blades

aged
bronze
dark
cherry
TF971AZ-220

INCLUDED:

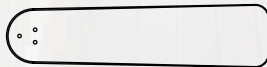

blade set

**ENERGY INFORMATION
AT HIGH SPEED:**

Airflow
8053
Cubic Feet
Per Minute

Electricity Use
79
Watts
(excluding lights)

Airflow Efficiency
102
Cubic Feet Per
Minute Per Watt



3-SPEED AC
reverse switch
on fan

CONTROL
pull chain

WET (IP21)
indoor/outdoor

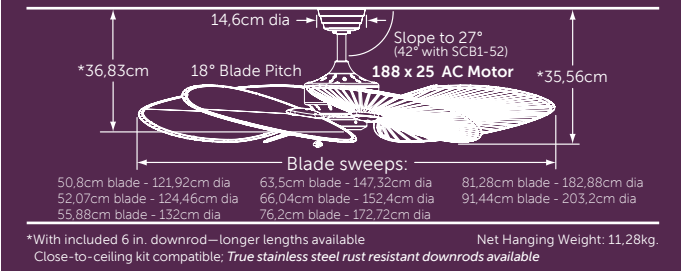

LIMITED LIFETIME MOTOR WARRANTY



MOTOR: MA7500AB-220 (1)
antique brass assembly
BLADES: B5340WA (1)
132cm sweep walnut carved wood



MOTOR: MA7500OB-220 (1)
oil-rubbed bronze assembly
BLADES: BPW20CY (1)
121,92cm sweep all-weather composite cherry
LIGHT KIT: LKLP102OB-220 (1)
opal frosted glass low profile
CLOSE TO CEILING KIT: CCK8002OB (1)
oil-rubbed bronze



MOTOR: MA7500RS-220 (1)
rust assembly
BLADES: B5280WA (1)
132cm sweep walnut wide oval leaf carved wood



SOLD SEPARATELY:



blade options: p.65-66
control options: p.63-64
light options: p.61

WINDPOINTE® CUSTOM

MOTOR: MA7500RS-220 (1)
rust assembly
BLADES: ISD1A (1)
132cm sweep walnut wide
oval leaf carved wood

antique
brass

MA7500AB-220

oil-rubbed
bronze

MA7500OB-220

rust

MA7500RS-220



MIX & MATCH
components
sold separately



3-SPEED AC
reverse switch
on fan



CONTROL
pull chain



DRY OR DAMP
model specific

ENERGY INFORMATION AT HIGH SPEED:

Airflow measured with
BPW6030 blades

Airflow

5188

Cubic Feet
Per Minute

Electricity Use

56

Watts
(excluding lights)

Airflow Efficiency

93

Cubic Feet Per
Minute Per Watt



LIMITED LIFETIME MOTOR WARRANTY

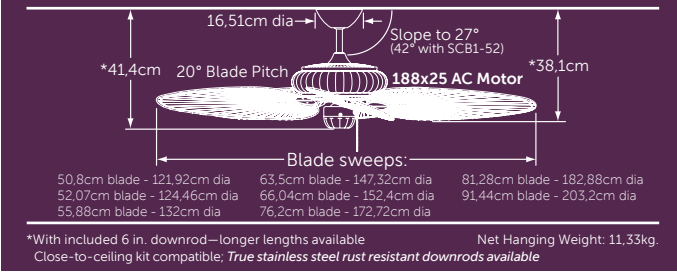

FAN: FP4320AZ1-220 (1)
aged bronze assembly
BLADES: BPD4A (1)
132cm sweep all-weather
composite antique woven
bamboo narrow oval



FAN: FP4320TB1-220 (1)
textured black assembly
BLADES: BPP4BR (1)
132cm sweep all-weather
composite brown/red
woven bamboo narrow oval



FAN: FP4320TS1-220 (1)
tortoise shell assembly
BLADES: B5340WA (1)
132cm sweep walnut
carved wood





SOLD SEPARATELY:



blade options: p.65-66
control options: p.63-64
light options: p.61

BELLERIA®

 **FAN: FP4320AZ1-220** (1)
 aged bronze assembly
BLADES: BPW6090DNA (1)
 152.4cm sweep all-weather composite
 dark natural accent narrow palm

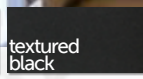
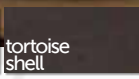
		
aged bronze	textured black	tortoise shell
FP4320AZ1-220	FP4320TB1-220	FP4320TS1-220

MIX & MATCH
 components
 sold separately

3-SPEED AC
 reverse switch
 on fan

CONTROL
 pull chain

DRY/WET (IP21)
 blade finish
 specific

ENERGY INFORMATION
AT HIGH SPEED:
 Airflow measured with
 BPP4 blades

Airflow
4379
 Cubic Feet
 Per Minute

Electricity Use
51
 Watts
 (excluding lights)

Airflow Efficiency
86
 Cubic Feet Per
 Minute Per Watt



LIMITED LIFETIME MOTOR WARRANTY

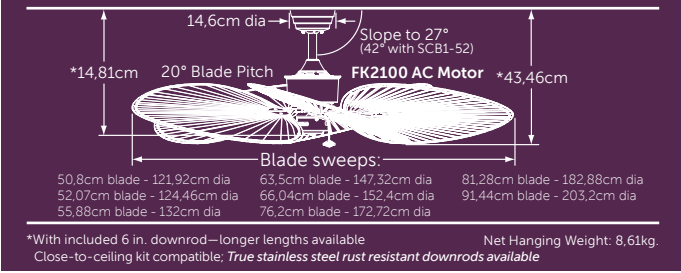

FAN: FP320AB1-220 (1)
antique brass assembly
BLADES: ISP1 (1)
132cm sweep natural palm leaf wide oval

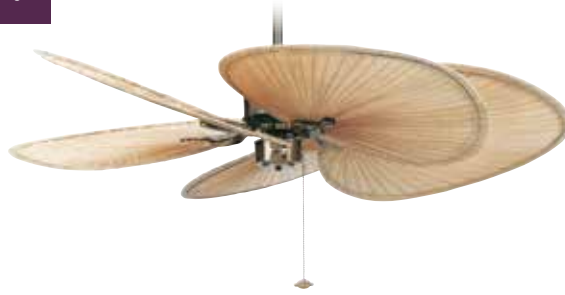

FAN: FP320OB1-220 (1)
oil-rubbed bronze assembly
BLADES: BPW20CY (1)
121,92cm sweep all-weather composite cherry



FAN: FP320PW1-220 (1)
pewter assembly
BLADES: B5133TKMH (1)
132cm sweep reversible teak/mahogany wood blades
● teak side showing



SOLD SEPARATELY:



blade options: p.65-66
control options: p.63-64
light options: p.61

ISLANDER® AC

FAN: FP320OB1-220 (1)
oil-rubbed bronze assembly
BLADES: ISD4A (1)
132cm sweep antique narrow
oval woven bamboo

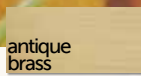
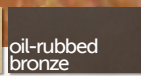
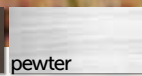
- 
**antique
brass**
FP320AB1-220
- 
**oil-rubbed
bronze**
FP320OB1-220
- 
pewter
FP320PW1-220



MIX & MATCH
components
sold separately



3-SPEED AC
reverse switch
on fan



CONTROL
pull chain



DRY/DAMP (IP20)
model specific

ENERGY INFORMATION AT HIGH SPEED:

Airflow measured with
BPW6030 blades

Airflow
6351
Cubic Feet
Per Minute

Electricity Use
90
Watts
(excluding lights)

Airflow Efficiency
71
Cubic Feet Per
Minute Per Watt



LIMITED LIFETIME MOTOR WARRANTY

For dimensions and configurations, please see our comprehensive Specification Book or model-specific specification sheet, available at fanimation.com

- ◆ **FAN: FP410AB-220** (1)
antique brass short assembly
- ◆ **BLADE SET: FP1018** (1)
127cm sweep reversible oak/walnut wood blades
- oak side showing



- **FAN: FP410BL-220** (1)
black short assembly
- **BLADE SET: BPP4TN** (1)
132cm sweep natural finish narrow oval all-weather composite palm blades



SOLD SEPARATELY:



blade options: p.65-66
control options: p.63-64
light options: p.61

AMERICANA®

-  **FAN: FP410AB-220** (1)
antique brass short assembly
- BLADE SET: FP1018** (1)
127cm sweep reversible oak/
walnut wood blades
 - oak side showing

antique
brass

FP410AB-220

black

FP410BL-220



MIX & MATCH
components
sold separately



3-SPEED AC
reverse switch
on fan



CONTROL
pull chain



DRY/DAMP (IP20)
model specific

LIMITED LIFETIME MOTOR WARRANTY

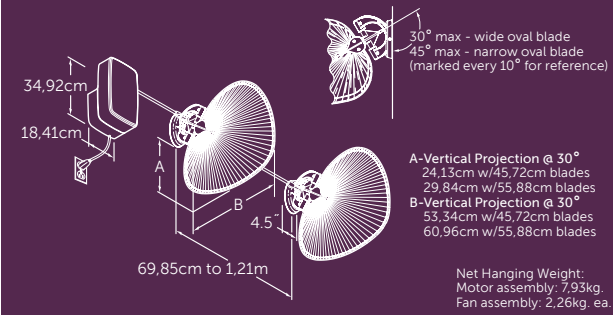

Not recommended for use in sound sensitive areas.

- ❖ **MOTOR: FP780AB-220** (1)
antique brass
- FAN ASSEMBLIES: FP720AB** (4)
antique brass
- BLADES: PUP1** (4)
55.88cm natural palm leaf wide oval



- ❖ **MOTOR: FP780PW-220** (1)
pewter
- FAN ASSEMBLIES: FP720PW** (6)
pewter
- BLADES: PUD1A** (6)
55.88cm antique woven bamboo wide oval



- 💧 **MOTOR: FP780RS-220** (1)
rust
- FAN ASSEMBLIES: FP720RS** (4)
rust
- BLADES: PUD1A** (4)
55.88cm antique woven bamboo wide oval



SOLD SEPARATELY:



See page 65-66 for blade options

PUNKAH®

 **MOTOR: FP780PW-220** (1)
 pewter
FAN ASSEMBLIES: FP720PW (5)
 pewter
BLADES: PUP1 (5)
 55,88cm natural palm leaf
 wide oval

antique
 brass
FP780AB-220
FP720AB

pewter
FP780PW-220
FP720PW

rust
FP780RS-220
FP720RS

POWER CORD
 0,6m cord



MIX & MATCH
 components
 sold separately

1-SPEED AC
 no reverse

DRY/DAMP (IP20)
 model specific

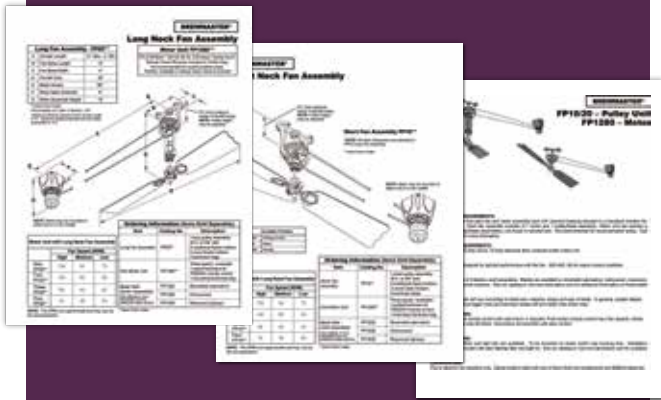

LIMITED LIFETIME MOTOR WARRANTY



For dimensions and configurations, please see our comprehensive Specification Book or model-specific specification sheet, available at fanimation.com

Not recommended for use in sound sensitive areas.





The Brewmaster® carries on Fanimation's reputation for reproducing unusual, yet functional, belt-drive fans. These fans were originally produced in the late 1800s by Snediker & Carr®, the premier belt-drive fan manufacturer of their day. Fanimation has adapted this timeless masterpiece to install and operate with more ease and durability.

- Neoprene belting replaces the high-maintenance leather belts.
- Lead and copper babbitt sleeves have given way to sealed ball bearings.
- Hardwood laminate blades that resist warping and splitting replace the temperamental solid wood blades.

The Brewmaster® combines the latest technology with several blade options including the original oversized wood blade design. The Brewmaster® is powered by a gearless direct drive motor, and allows you to operate one or two fans.

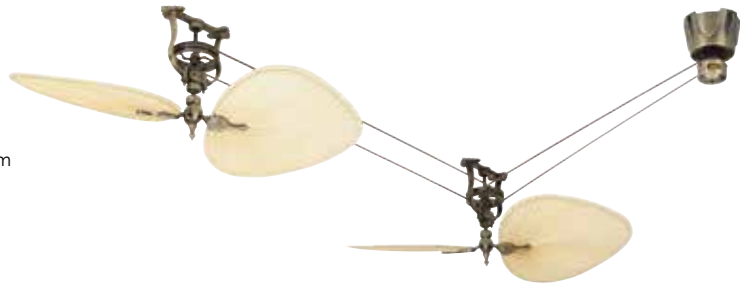
-  **MOTOR: FP1280AB-220** (1)
 antique brass
HEAD: FP10AB (2)
 antique brass short neck assembly
BLADE SET: BMP1 (2)
 127cm sweep natural finish wide oval palm



-  **MOTOR: FP1280BL-220** (1)
 black (required but not shown)
HEAD: FP20BL (1)
 black long neck assembly
BLADE SET: BMD4A (1)
 127cm sweep narrow oval woven bamboo

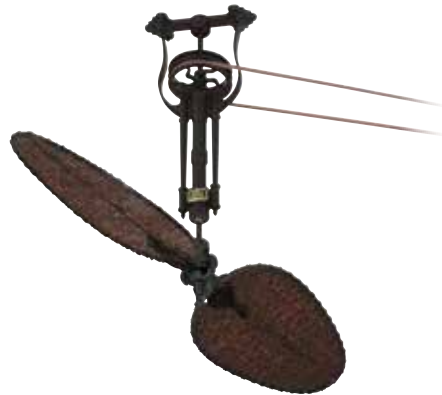

-  **MOTOR: FP1280PW-220** (1)
 pewter (required but not shown)
HEAD: FP10PW (1)
 pewter short neck assembly
BLADE SET: FP1030 (1)
 142,24cm sweep rosewood



SOLD SEPARATELY:

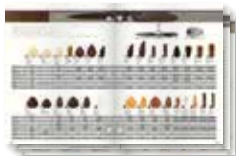

additional blade options: p.65-66
 control options: p.63-64
 light options: p.61



reversible oak/walnut

FP1022
wood 



cherry

FP1026
wood 



rosewood

FP1030
wood 

BREWMASTER™

 **MOTOR: FP1280BL-220** (1)
 black (required but not shown)
HEAD: FP20BL (1)
 black long neck assembly
BLADE SET: FP1026 (1)
 63,5cm cherry

antique brass

FP1280AB-220
FP10AB
FP20AB

black

FP1280BL-220
FP10AB
FP20AB

pewter

FP1280PW-220
FP10AB
FP20AB

INCLUDED:



C3-220



MIX & MATCH
 components
 sold separately



3-SPEED AC
 reverse switch
 on remote



CONTROL
 wall



DRY/DAMP (IP20)
 model specific

FAN SPEED (RPM): Fan Assemblies

	High	Medium	Low
One	127	100	82
Two	106	60	46
Three	89	46	35
Four	76	38	28



LIMITED LIFETIME MOTOR WARRANTY





PORTABLES



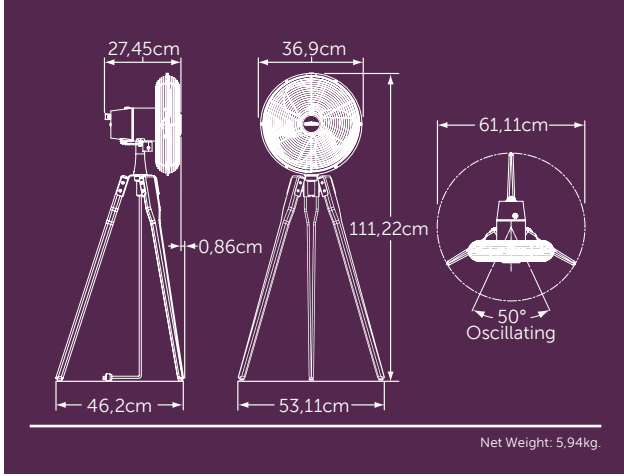

FAN: FP8014OB-220 (1)
oil-rubbed bronze assembly with black blades and walnut legs



FAN: FP8014SN-220 (1)
satin nickel assembly with black blades and walnut legs





ARDEN™

 **FAN: FP8014SN-220 (1)**
satin nickel assembly with
walnut legs

oil-rubbed bronze	satin nickel
walnut	walnut
FP8014OB-220	FP8014SN-220



3-SPEED
no reverse



POWER CORD
2,43m cord



CONTROL
rotary



DRY (IP20)
indoor only



LIMITED LIFETIME MOTOR WARRANTY

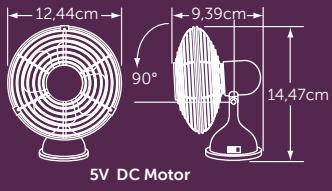

Net Weight: 0,5kg.

FAN: FP6252BN (1)
brushed nickel assembly with
brushed nickel fan blades and
brushed nickel cage



FAN: FP6252BN (1)
brushed nickel assembly with
brushed nickel fan blades and
brushed nickel cage



FAN: FP6252BN (1)
brushed nickel assembly with
brushed nickel fan blades and
brushed nickel cage



MINI BREEZE™



brushed nickel
brushed nickel
FP6252BN

 **FAN: FP6252BN (1)**
brushed nickel assembly with
brushed nickel blades and
brushed nickel cage

 **USB**

USB PLUG



1-SPEED
no reverse



DRY (IP20)
indoor only

INCLUDED:

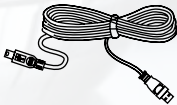

USB power cord

LIMITED LIFETIME MOTOR WARRANTY

LIGHT KITS

- Light kits are for use with most Fanimation fans
- Light bulb requirements vary and are listed for each light kit
- Pull-chain light kits come with chain and fob
- Light bulbs included



- ◊ **LKLP101SN-220** satin nickel
- low-profile light kit
 - opal frosted glass
 - pull chain operation
 - 21,59cm (H) x 13,2cm (W)
 - One 100W halogen minican bulb included



- ◊ **LKLP102OB-220** oil-rubbed bronze
◊ **LKLP102SN-220** satin nickel
- low-profile light kit
 - opal frosted glass
 - pull chain operation
 - 20,32cm (H) x 13,2cm (W)
 - One 100W halogen minican bulb included



- ◊ **LKLP112AOB-220** oil-rubbed bronze
- low-profile light kit
 - amber linen glass
 - pull chain operation
 - 21,59cm (H) x 13,2cm (W)
 - One 100W halogen minican bulb included



- ◊ **LKLP112WSN-220** satin nickel
- low-profile light kit
 - white linen glass
 - pull chain operation
 - 21,59cm (H) x 13,2cm (W)
 - One 100W halogen minican bulb included

FITTERS, SHADES & DECORATIVE GLASS

- Fitters are for use with most Fanimation fans
- Fitter glass sold separately below
- Finishes and light bulb requirements vary and are listed for each
- Glass and shades should be ordered based on the fitter model selected
- Glass bowls—32,38cm diameter x 12,06cm height (G210 and G400 series) require fitters F423-220 and FW423-220
- Light bulbs included



- ◆ **F423AB-220** antique brass
◊ **F423AZ-220** aged bronze
◊ **F423OB-220** oil-rubbed bronze
◆ **F423PW-220** pewter
◊ **F423RS-220** rust
◊ **F423SN-220** satin nickel
- 15,24cm (H) x 15,24cm (W)
 - Three 60W candelabra bulbs included



- ◆ **FW423RS-220** rust
◆ **FW423TS-220** tortoise shell
◆ **FW423WH-220** white
- Uses glass bowls only, sold separately below
 - 17,78cm (H) x 33,02cm (W)
 - Three 40W candelabra bulbs included



G210
Tropical bowl



G439
Hand-painted parrot



G450
Amber



G451
Powdered amber



G456
White frost

DOWNRODS & ACCESSORIES

DOWNRODS

- Order according to length
- Use finish code to complete the part number
- See page 3 for suggested lengths

STEEL	*DR1-6**	6 in. (15,24cm) downrod
	DR1-12**	12 in. (30,48 cm) downrod
	DR1-18**	18 in. (47,72cm) downrod
	DR1-24**	24 in. (60,96cm) downrod
	DR1-36**	36 in. (91,44cm) downrod
	DR1-48**	48 in. (121,92cm) downrod
	DR1-60**	60 in. (152,4cm) downrod
	DR1-72**	72 in. (182,88cm) downrod



STAINLESS STEEL	DR1SS-12***	12 in. (30,48 cm) downrod
	DR1SS-18***	18 in. (47,72cm) downrod
	DR1SS-24***	24 in. (60,96cm) downrod
	DR1SS-36***	36 in. (91,44cm) downrod
	DR1SS-48***	48 in. (121,92cm) downrod
	DR1SS-60***	60 in. (152,4cm) downrod
	DR1SS-72***	72 in. (182,88cm) downrod

TRUE STAINLESS STEEL DOWNROD.
Wet location rated. Resistant to rust and corrosion.



DOWNROD COUPLERS

- Joins two downrods together for extended lengths
- When ordering, use finish code for steel downrods shown above to complete the part number.

DR1-CP** 1 in. diameter downrod coupler

CLOSE-TO-CEILING KIT



- Replaces hanger bracket/downrod assembly to move your fan closer to the ceiling, creating more head room
- Intended for use with low ceilings.
- Please see individual fan pages for compatibility
- Tall dimensions: 13cm (H) x 20,32cm (DIA.)
- Short dimensions: 6,78cm (H) x 20,32cm (DIA.)

STANDARD

CCK8002AB	antique brass	CCK8002OB	oil-rubbed bronze
CCK8002AZ	aged bronze	CCK8002PW	pewter
CCK8002BL	black	CCK8002RS	rust
CCK8002BN	brushed nickel	CCK8002SN	satin nickel
CCK8002DZ	dark bronze	CCK8002TS	tortoise shell
CCK8002MW	matte white	CCK8002WH	white

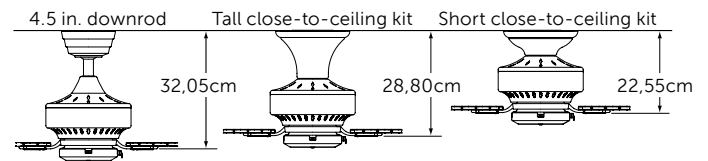

WET RATED

CCK8002BLW	black wet	CCK8002OBW	oil-rubbed bronze wet
CCK8002BNW	brushed nickel wet	CCK8002SNW	satin nickel wet
CCK8002DZW	dark bronze wet	CCK8002WHW	white wet
CCK8002MWW	matte white wet		

SLOPED CEILING BALL KIT



- Includes black hanger ball only
 - For use with Fanimation fans purchased after June 2004
 - See individual fan pages for compatibility with your fan
 - Hanger ball works with current Fanimation canopy and hanger bracket
 - Allows for ceiling slope up to 42°
 - For use with any length downrod
- SCB1-52 For use with 1 in. dia. downrods

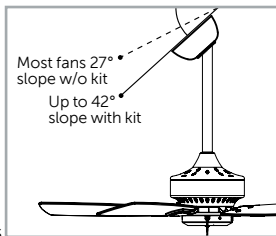

DOWNROD SLEEVE





- Tropical downrod sleeve
 - 40,64cm tall
 - Requires minimum 24 in. downrod or extension pole
- DRS24TR Downrod sleeve

CONTROLS

• Control options are not available for Bourbon Street®, Palmetto® and Punkah®

TUV LISTED

-  Included
 -  Optional
 -  Optional—Install control in a dry location only
- WH—White LA—Light Almond



C1-220

- 220v non-reversing fan-only wall control
- 100-watt max. fan load

C2-220

- 220v non-reversing fan and light wall control
- 100-watt max. fan load
- 300-watt max. light load

C3-220

- 220v non-reversing fan-only two-fan wall control
- 100-watt max. fan load

C6-220

- 220v non-reversing fan and light wall control
- Controls two fans
- 100-watt max. fan load
- 300-watt max. light load

CW40-220

- 220V non-reversing fan-only wall control
- 100-watt max. fan load

CW110-220

- 220V non-reversing fan-only wall control
- 100-watt max. fan load

Aire Décor®—BP200/220/225						
Americana®						
Ascension™						
Belleria®						
Benito™						
Bourbon Street®						
Brewmaster®						
Edgewood®						
Enigma®						
Extraordinaire®						
Hugh™ 44 & 52						
Islander® AC						
Levon™						
Odyn™						
Palmetto®						
Punkah®						
Spitfire™						
Windpointe®						
Xeno™						
Zonix™—FP4620 & FP4630						
Zonix™ (WET)—FP4640						

BLADES

- Blades listed come in sets of five (5) except those for Punkah®—one (1), Brewmaster®—two (2), and Palmetto—three (3).
- Blades should be ordered based on the fan model selected
- Blade sets vary based on catalog number and are specific to fan models
- Some blade catalog numbers require fan finish codes
- Due to the nature of the materials and the hand-crafted processes; stain, color, texture and shading will vary



Americana®	ISP1		ISP4	FP1018	B5280WA	B6080WA	
Belleria®	ISP1		ISP4		B5280WA	B6080WA	
Bourbon Street®	ISP1		ISP4	FP1018	B5280WA	B6080WA	
Brewmaster®	BMP1						
Islander® AC	ISP1		ISP4		B5280WA	B6080WA	
Palmetto®		PMP2**					
Punkah®	PUP1						
Windpointe® Custom	ISP1		ISP4		B5280WA	B6080WA	



Americana®	ISD1A		ISD4A	BPD1A	BPD4A	BPD4MW	
Belleria®	ISD1A		ISD4A	BPD1A	BPD4A	BPD4MW	
Bourbon Street®	ISD1A		ISD4A	BPD1A	BPD4A	BPD4MW	
Brewmaster®			BMD4A				
Islander® AC	ISD1A		ISD4A	BPD1A	BPD4A	BPD4MW	
Palmetto®		PMD2A**					
Punkah®	PUD1A	PUD1C					
Windpointe® Custom	ISD1A		ISD4A	BPD1A	BPD4A	BPD4MW	

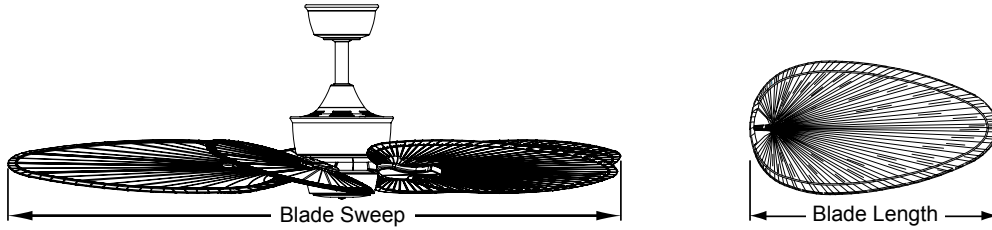

	B5340WA	B5350WA	B5300WA	B5330WA	B6130WA	B5133TKMH	B6133TKMH
	B5340WA	B5350WA	B5300WA	B5330WA	B6130WA	B5133TKMH	B6133TKMH
	B5340WA	B5350WA	B5300WA	B5330WA	B6130WA	B5133TKMH	B6133TKMH
	B5340WA	B5350WA	B5300WA	B5330WA	B6130WA	B5133TKMH	B6133TKMH
	B5340WA	B5350WA	B5300WA	B5330WA	B6130WA	B5133TKMH	B6133TKMH



	BPP1TN	BPP4TN	BPP1BR	BPP4BR	BPW20CY	BPW24MW	BPW6090DNA	BPW6030MH	BPW6030TK
	BPP1TN	BPP4TN	BPP1BR	BPP4BR	BPW20CY	BPW24MW	BPW6090DNA	BPW6030MH	BPW6030TK
	BPP1TN	BPP4TN	BPP1BR	BPP4BR	BPW20CY	BPW24MW	BPW6090DNA	BPW6030MH	BPW6030TK
	BPP1TN	BPP4TN	BPP1BR	BPP4BR	BPW20CY	BPW24MW	BPW6090DNA	BPW6030MH	BPW6030TK
	BPP1TN	BPP4TN	BPP1BR	BPP4BR	BPW20CY	BPW24MW	BPW6090DNA	BPW6030MH	BPW6030TK

ANTIQUe FAN MUSEUM

presented by the Antique Fan Collectors Association



PASSION, HERITAGE & PRESERVATION

Led by our Founder and CEO, Tom Frampton, Fanimation is dedicated to preserving the history of fans and the fan industry. For years, Tom has been an avid antique fan collector and member of the Antique Fan Collectors Association (AFCA). The AFCA membership has operated a museum since 1997, displaying fans on loan by the membership; this museum was in Wichita, Kansas up until 2008, when the need to relocate the museum arose. Answering the call to preserve viewing of the one-of-a-kind collection, Fanimation made the offer to house the museum at its facility in Zionsville. The move and set-up took nearly a year and the museum saw its reopening July 23, 2009. Since that time, the museum has grown and continues to grow, housing over a thousand antique fans on two floors. Tom's own unique collection of fans is a part of the museum collection along with over 500 antique advertising style hand fans and other fan memorabilia.





LOCATION

10983 Bennett Parkway
Zionsville, IN 46077



HOURS

Monday thru Friday 10 am - 4 pm
Or call for an appointment, 317-733-4113



MUSEUM HIGHLIGHTS

- The AFCA museum contains more than 1,000 antique ceiling, desk and hand fans with over 140 manufacturers represented
- The oldest electric desk fan in the museum dates from the early 1890's
- The oldest non-electric fans (steam, belt & pulley or water powered) date from the early 1880's.
- It is the only antique fan museum open to the public in the world
- The AFCA has approximately 700 members worldwide
- The museum contains some of the earliest battery-powered fans, water-powered fans, wind-up fans, electric hand-held fans, ceiling fans, wall fans, desk fans, pedestal fans, rail-car fans and fans that don't even look like fans.
- The museum contains hundreds of hand-held fans that feature advertising from manufactures, retailers, politicians and movie stars.



INDEX

FANS	PAGE	FITTERS	PAGE	BLADES	PAGE
BP200**1-220	15, 16	F423**-220	61	ISP4	65
BP220**1-220	15, 16	FW423**-220	61	PMP2	65
BP225OB1-220	15, 16			PUD1A	51, 65
FP10**	53, 54	GLASS & SHADES	PAGE	PUD1C	65
FP1280**-220	53, 54	G210	61	PUP1	51, 65
FP20**	53, 54	G439	61		
FP2120MG-220	27, 28	G450	61	CONTROLS	PAGE
FP320**1-220	47, 48	G451	61	C1-220	63
FP410**-220	49, 50	G456	61	C2-220	63
FP4320**1-220	45, 46			C3-220	54, 63
FP4620**-220	9, 10	BLADES	PAGE	C6-220	63
FP4640**-220	33, 34	B4400SN	9	CW6717WH-220	30, 64
FP510**	17, 18	B4442**	9	CW6721WH-220	38, 64
FP520**	17, 18	B5133TKMH	47, 66	CW6729WH-220	32, 64
FP540**	17, 18	B5280WA	43, 65	CW8332-220	22, 64
FP580**-220	17, 18	B5300WA	66	CW8355-220	24, 64
FP601**-220	17, 18	B5330WA	66	CRL4WH-220	64
FP602**-220	17, 18	B5340WA	43, 45, 66	CW110-220	26, 63
FP603**-220	17, 18	B5350WA	66	CW40-220	10, 63
FP604**-220	17, 18	B6080WA	65	TR39ND-220	36, 64
FP605**-220	17, 18	B6130WA	66	TR4WH-220	28, 64
FP6252BN	59, 60	B6133TKMH	66	TRL4WH-220	14, 64
FP6717**-220	29, 30	B6720**	37, 38		
FP6729**-220	31, 32	BMD4A	53, 65	ACCESSORIES	PAGE
FP720**	51, 52	BMP1	53, 65	CCK8002**	62
FP780**-220	51, 52	BPD1A	65	CCK8002**W	62
FP7910OB-220	11, 12	BPD4A	45, 65	DR1-12**	62
FP8003**-220	13, 14	BPD4MW	65	DR1SS-12**W	62
FP8014**-220	57, 58	BPP1BR	66	DR1-18**	62
FPD8148**-220	35, 36	BPP1TN	66	DR1SS-18**W	62
FPS8332**-220	21, 22	BPP4BR	45, 66	DR1-24**	62
FPS8355**-220	23, 24	BPP4TN	49, 66	DR1SS-24**W	62
MA6721**-220	37, 38	BPW20CY	43, 47, 66	DR1-36**	62
MA7500**-220	43, 44	BPW24MW	66	DR1SS-36W**	62
OF110**-220	25, 26	BPW4426**	9, 33	DR1-48**	62
TF910**-220	39, 40	BPW4442**	9	DR1SS-48**W	62
TF971**-220	41, 42	BPW6030MH	66	DR1-60**	62
		BPW6030TK	66	DR1SS-60**W	62
LIGHT KITS	PAGE	BPW6090DNA	46, 66	DR1-60B	62
LK4640**-220	33	FP1018	17, 49, 65	DR1-72**	62
LK6721**-220	37, 38	FP1022	53	DR1SS-72**W	62
LKLP101SN-220	61	FP1026	53	DR1-CP**	62
LKLP102OB-220	43, 61	FP1030	53	DRS24TR	62
LKLP102SN-220	61	ISD1A	44, 65	SCB1-52	62
LKLP112AOB-220	61	ISD4A	48, 65		
LKLP112WSN-220	61	ISP1	47, 65		